

Вырезать окружность до склеивания, сделать прорезы в лепестках.

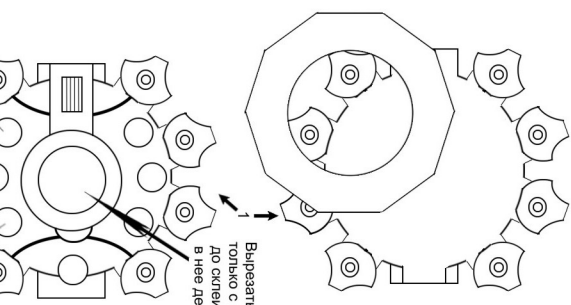

Вырезать эту окружность только с одной стороны до склеивания. Вырезать в нее деталь 12 или 12*

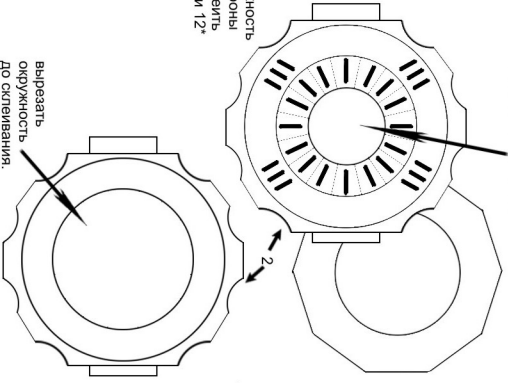

Вырезать окружность до склеивания.

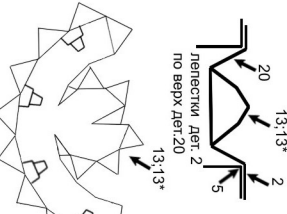
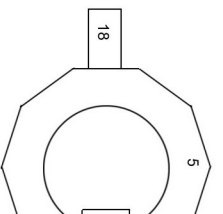

Дет. 13,13* 12,12* имеют несколько разные размеры.

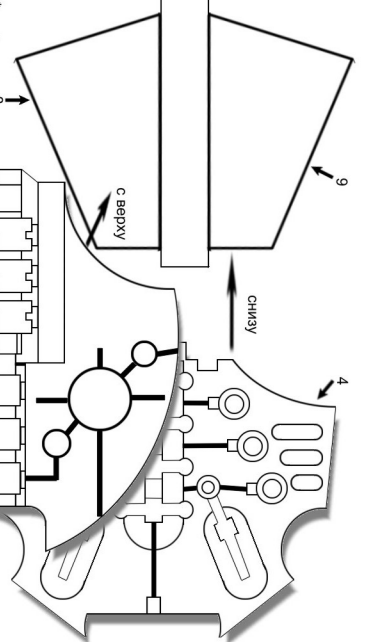

сверху
снизу

до склеивания согнуть по этой линии, склеить только верхнюю часть (над линией).

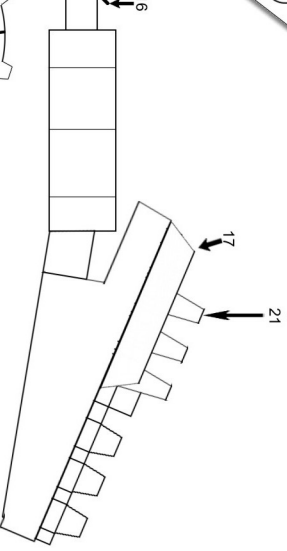
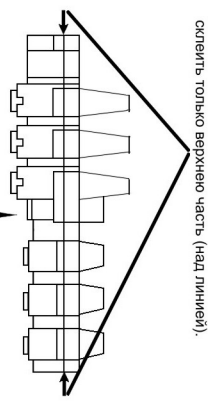

Согнуть как показано

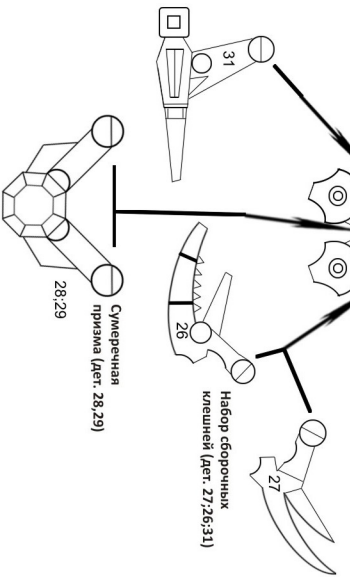

Набор сборочных клише (дет. 27,26,31)

Сумеречная призма (дет. 28,29)

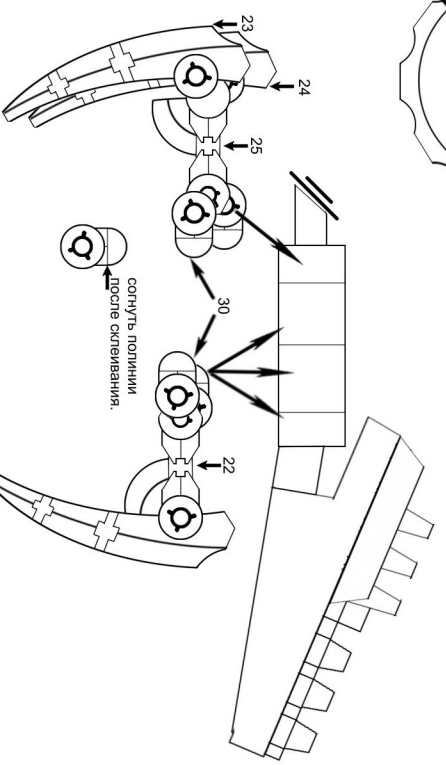

согнуть по линии после склеивания.

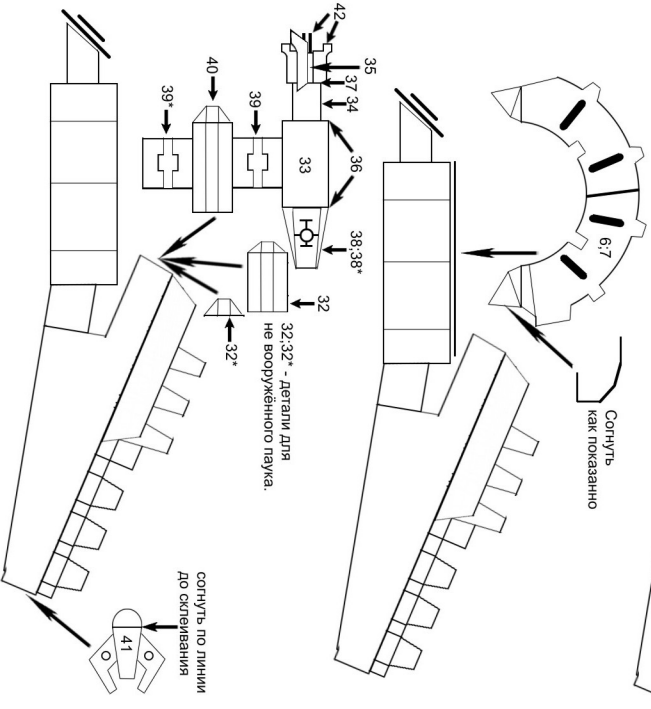

32,32* - детали для не вооружённого паука.

согнуть по линии до склеивания

